

Geometry Review
SHOW ALL WORK

Find the area of each shape.

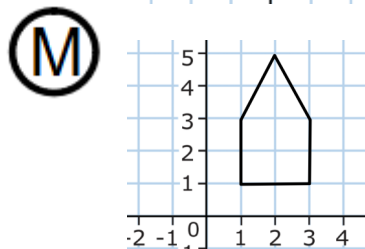

Find the value of the missing angle.

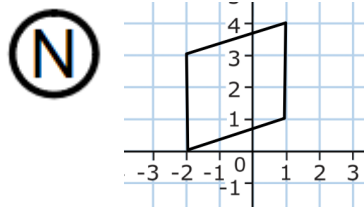
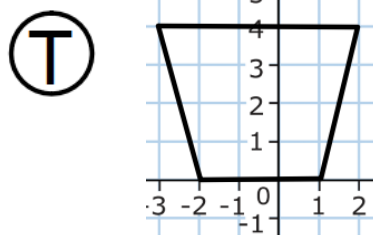
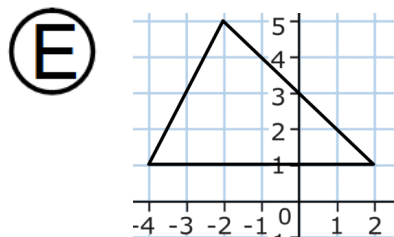
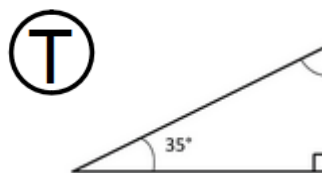
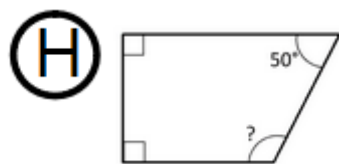
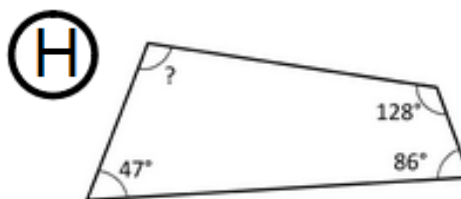
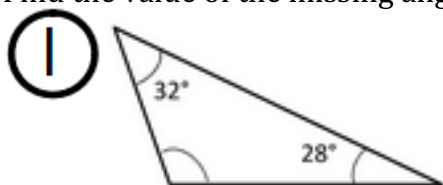

Find the area of the complex figure.

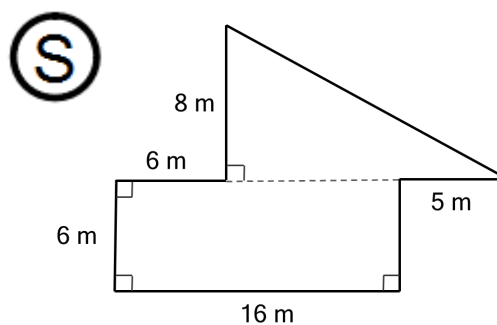
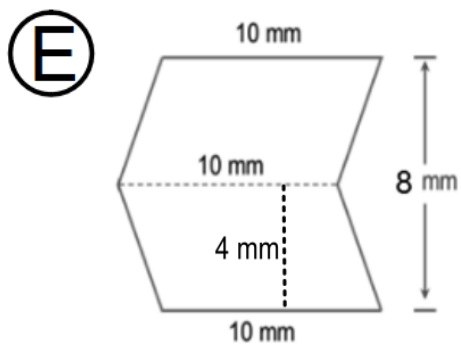
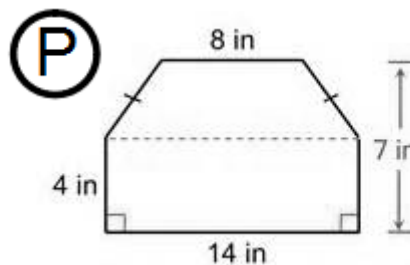
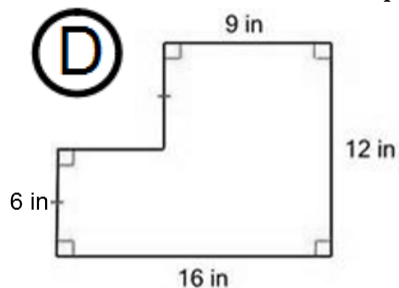

Find the volume of the rectangular prism.

Ⓐ

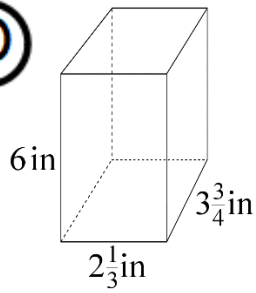

Ⓑ

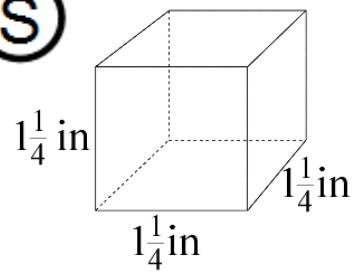

Ⓒ

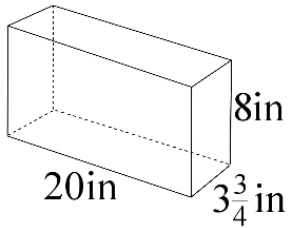

Ⓓ

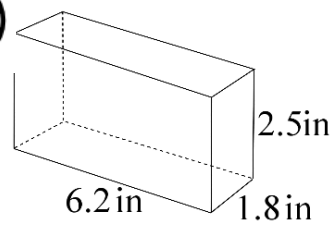

Find the surface area.

Ⓐ

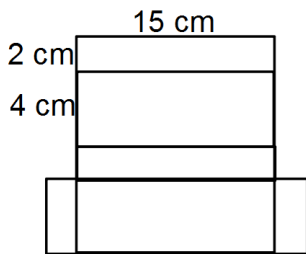

Ⓑ

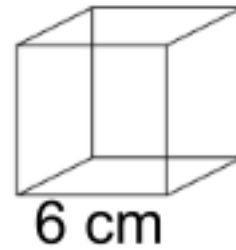

Ⓒ

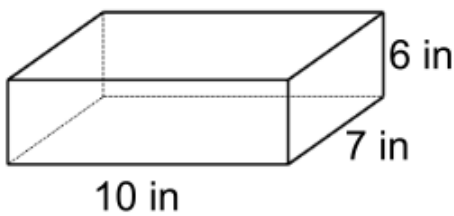

Ⓓ

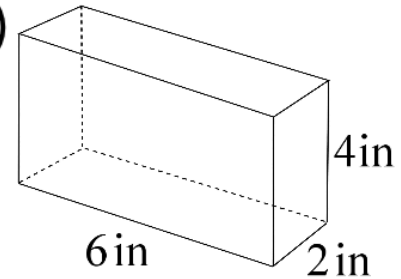

WHY DID IT TAKE THE BASEBALL PLAYER SO LONG TO RUN BETWEEN SECOND AND THIRD BASE?

55 130 80 600 12 120 $1\frac{61}{64}$ 216 156 99 $52\frac{1}{2}$ 196 27.9 156 16 $52\frac{1}{2}$ 89

120 9 16 99 88 6 120 150 150 344 80